

CURRENT TRANSFORMER

Model 144MR

Window Diameter 6.00"

REGULATORY AGENCY APPROVALS



Manufactured to meet the requirements of ANSI/IEEE C57.13.
Classified by U.L. in accordance with IEC 44-1

Approved for revenue metering by Industry Canada. No. AE-0642

APPLICATION:
Relaying.

FREQUENCY:
50-400Hz

INSULATION LEVEL:
0.6 kV, BIL 10 kV full wave.

CONTINUOUS THERMAL CURRENT RATING FACTOR:
See TRF at curves.

- Terminals are brass screws No.10-32 with one flatwasher and lockwasher.
- The transformer winding is arranged so that the turns are fully distributed between all taps.
- Order Mounting Bracket Kit No. 0221B00259 separately.
- Approximate weight 40 lbs.

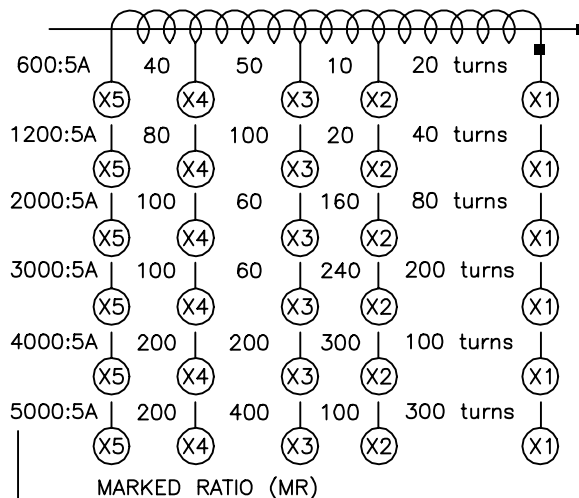
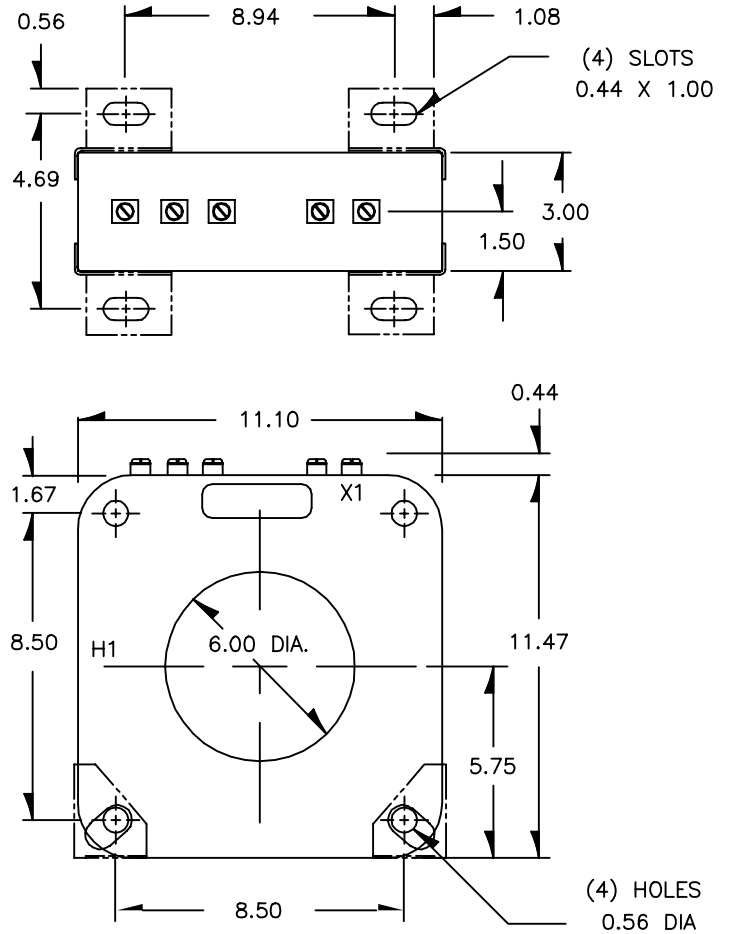
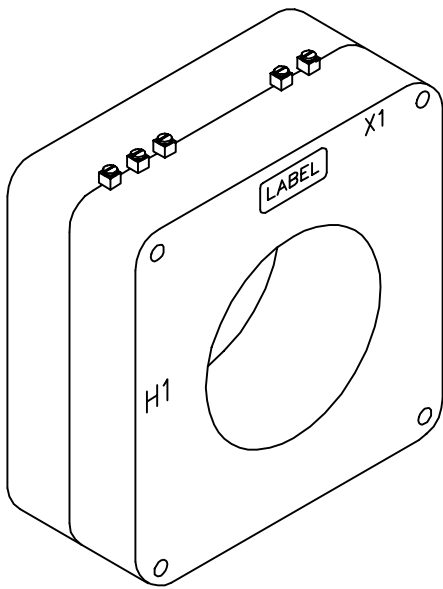

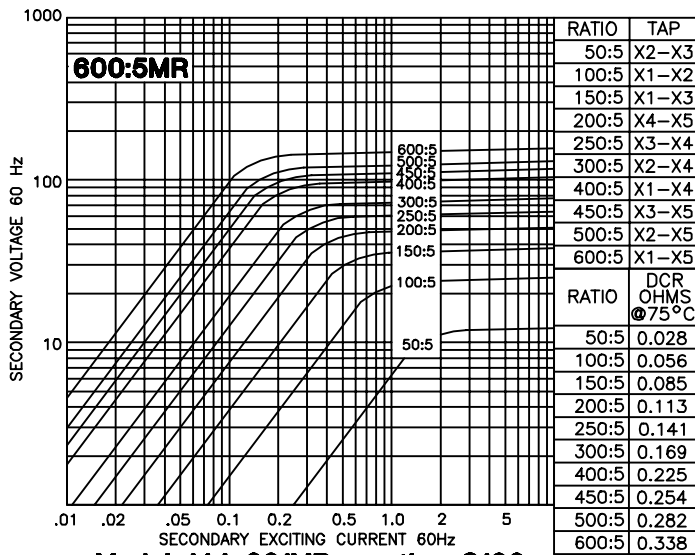

Model 144-601MR - rating C100
TRF= 2.0 @ 30°C, 1.5 @ 55°C amb.

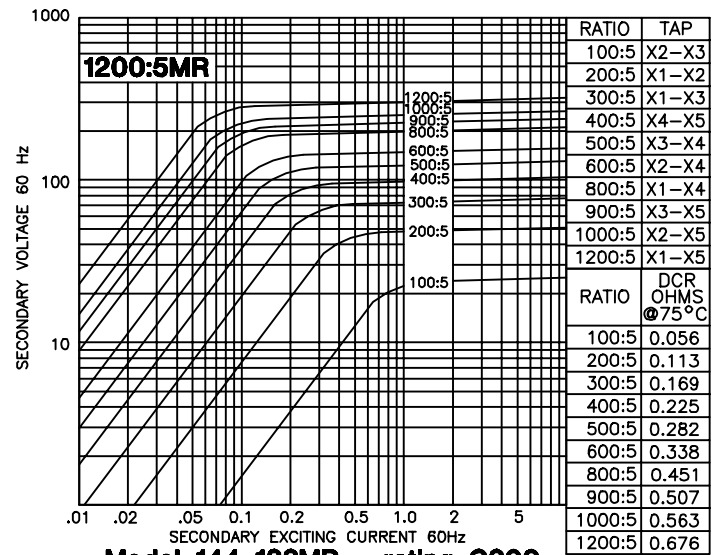

Model 144-122MR - rating C200
TRF= 2.0 @ 30°C, 1.5 @ 55°C amb.

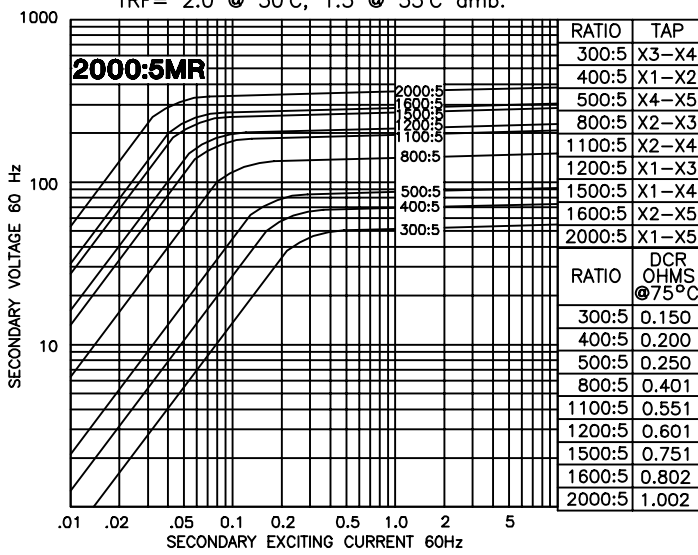

Model 144-202MR - rating C200
TRF= 1.5 @ 30°C, 1.0 @ 55°C amb.

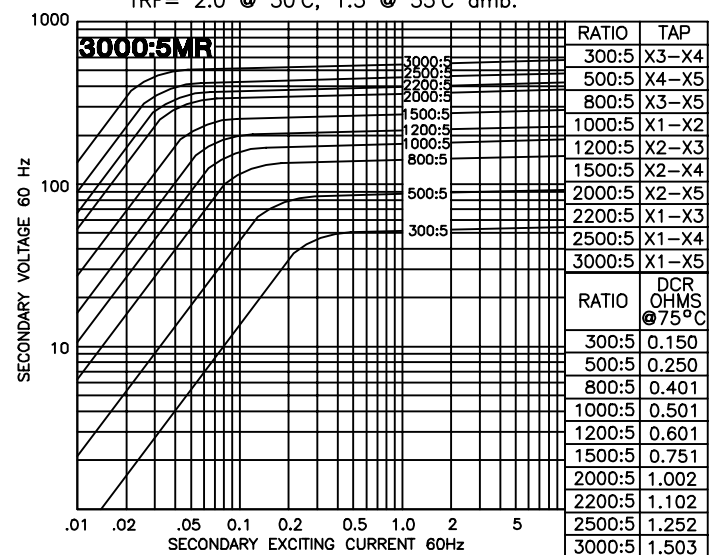

Model 144-302MR - rating C400
TRF= 1.0 @ 30°C, 0.8 @ 55°C amb.

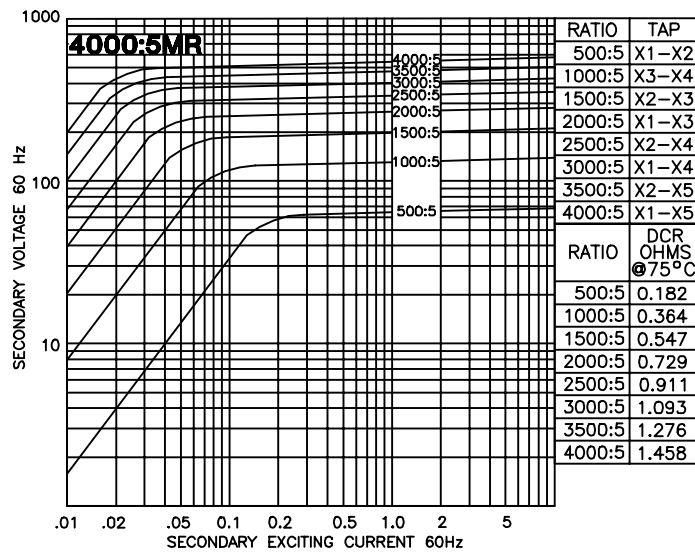

Model 144-402MR - rating C400
TRF= 1.0 @ 30°C, 0.8 @ 55°C amb.

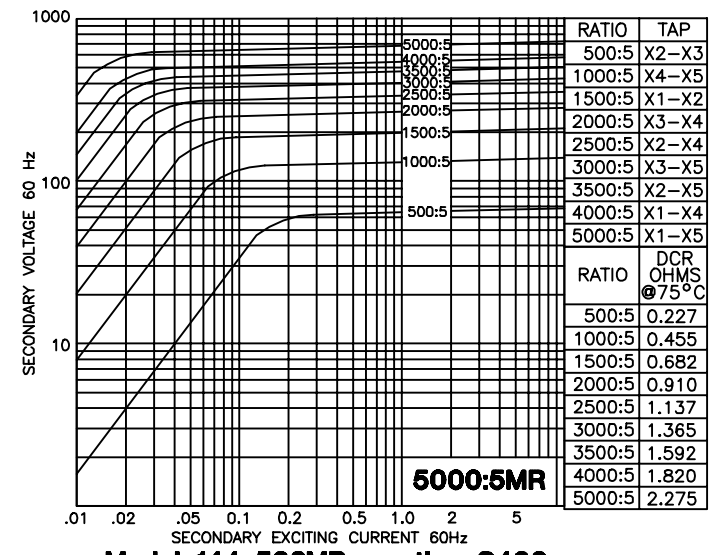

Model 144-502MR - rating C400
TRF= 1.0 @ 30°C, 0.6 @ 55°C amb.