

# CURRENT TRANSFORMERS

## Model 7

Window Diameter 2.50"

### APPLICATION:

With ammeters, wattmeters, and cross current compensation.

### FREQUENCY:

50-400 Hz.

### INSULATION LEVEL:

600 Volts, 10 kV BIL full wave.



- Flexible leads are UL 1015 105 ° C, CSA approved, #16 AWG, 24" long.
- Non-standard length to be specified.
- Terminals are brass studs No. 8-32 UNC with one flat washer, lockwasher and regular nut.
- SFT and SHT case styles also available as SFL and SHL with leads.
- Mounting bracket kit 0221B00182 when required for Model 7SHT.
- Approximate weight: 1.5 lb.

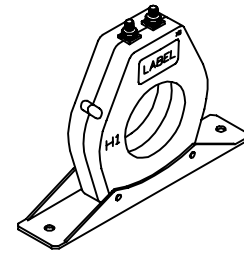
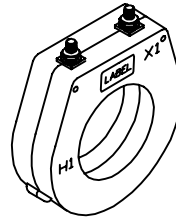
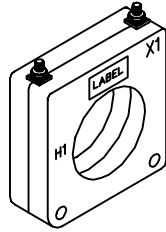
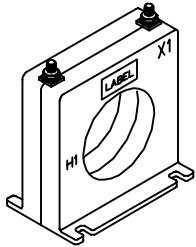

**7SFT**

**7SHT**

**7RT**

**7RBT**

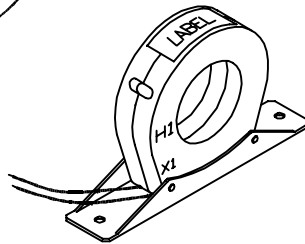
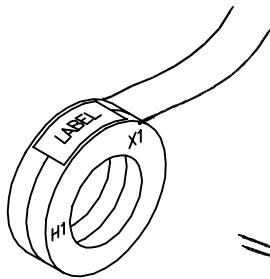
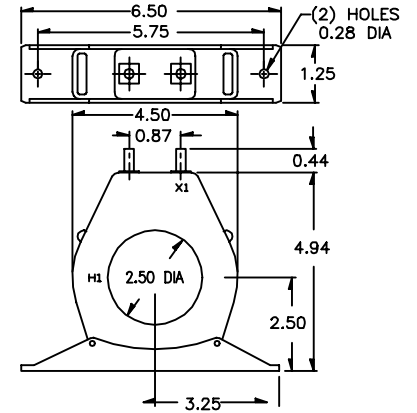
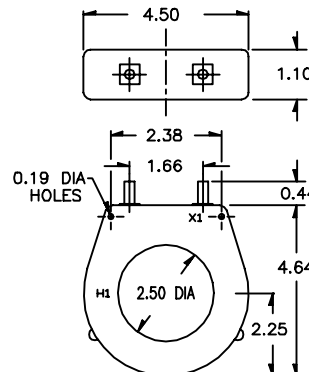
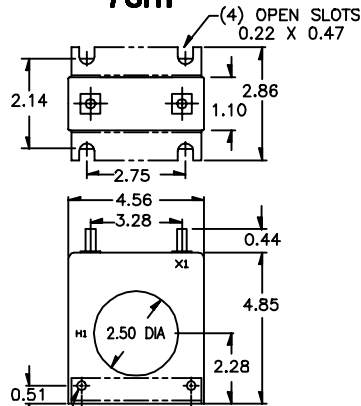
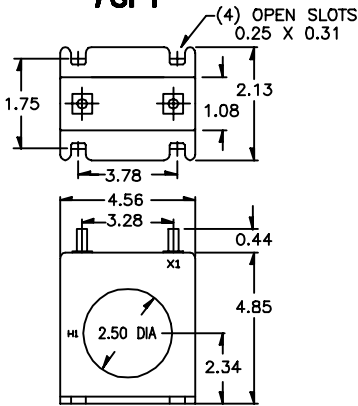

**7RL**

**7RBL**

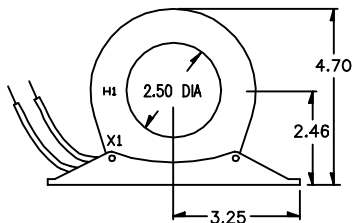
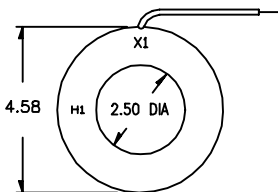
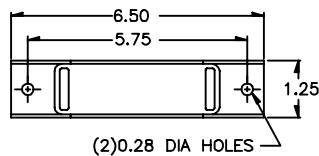
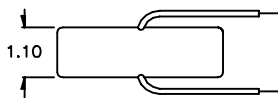

CATALOG NUMBER	CURRENT RATIO	ACCURACY AT 60 Hz	BURDEN VA at 60 Hz
7**-101	100:5	± 2 %	2.5
7**-151	150:5	± 1 %	5.0
7**-201	200:5	± 1 %	5.0
7**-251	250:5	± 1 %	5.0
7**-301	300:5	± 1 %	12.5
7**-401	400:5	± 1 %	15.0
7**-501	500:5	± 1 %	25.0
7**-601	600:5	± 1 %	30.0
7**-751	750:5	± 1 %	30.0
7**-801	800:5	± 1 %	35.0
7**-102	1000:5	± 1 %	35.0
7**-122	1200:5	± 1 %	35.0
7**-152	1500:5	± 1 %	40.0
7**-162	1600:5	± 1 %	45.0

\*\* NOTE: When ordering, prefix Cat No. with model designation required, i.e. 7SFT-500, 7RL-500, etc.